

HFP028

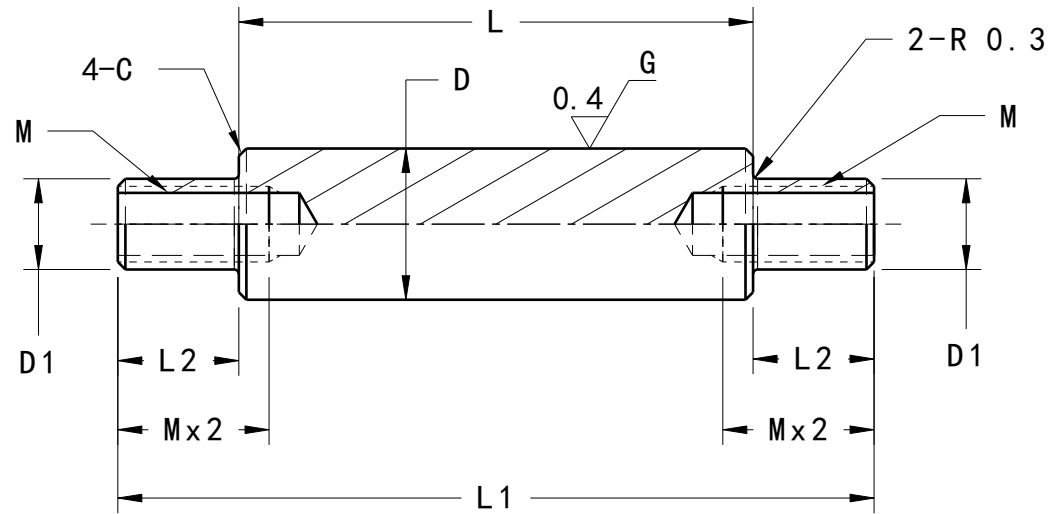

Section view A-A
Scale: 2:1