

HFP015

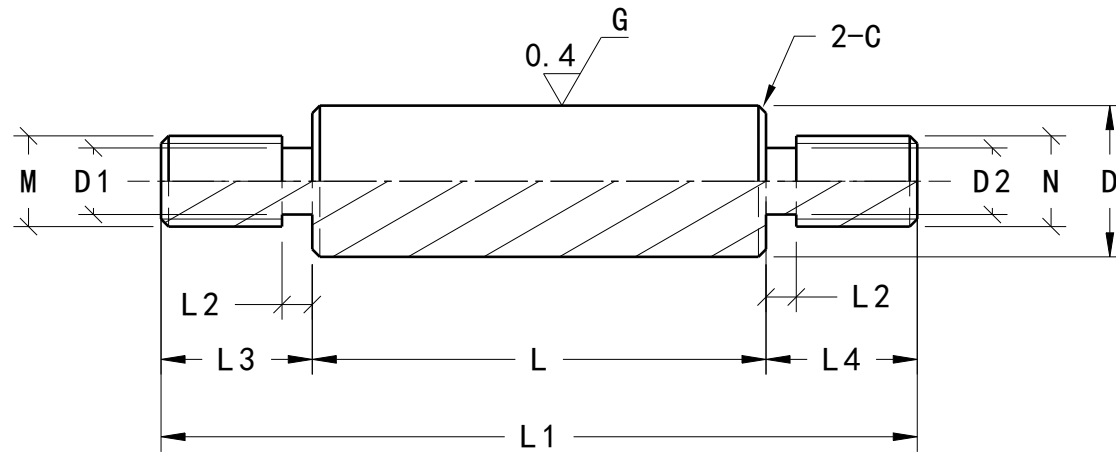

剖面視圖A-A
縮放: 2:1